

WT-250 II

NAKAMURA-TOME
PRECISION INDUSTRY CO.,LTD.

WT-250II

One hit machining
Finished parts, complete in one set up

High Productivity Multitasking Machine
From diversified small-lot production to mass production



High Rigidity Box-Type Slide-Ways on all Axes

Equipped with all box-type slide-ways, which are traditionally hand scraped by highly skilled technicians, according to stringent quality control standards. Having high rigidity slides, the high-output motors ensure powerful cutting. WT250II is the ultimate two-spindle Multitasking Turning Center, made with high-level skills and interactive technology.

WT-250II

Possibility of high-value added production

Major Improvements

for Diversified Variable-Lot-Size Production.



19"
Color LCD
Touch Panel

NT
Smart
X

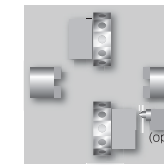

T_{x2}
Double turret

M_{x2}
Double Milling Motor

Y
Y-axis

S_{x2}
Twin-Spindle

C_{x2}
C-axes

Capacity

Max. turning diameter / Max. turning length	250mm / 555mm		
Distance between spindles (max / min)	885mm / 265mm		
Bar capacity	L : 65mm	R : 51mm	R : 65mm (op.)
Chuck size	8" 215mm	6" 165mm	

Axis travel

Slide travel (X1 / X2)	195mm / 195mm		
Slide travel (Z1 / Z2 / B)	600mm / 600mm / 620mm		
Slide travel (Y) upper turret	±41mm (op.)		

Spindle L, R

	L: φ65mm	R: φ51mm	R: φ65mm (op.)
Spindle speed	4500min ⁻¹	5000min ⁻¹	4500min ⁻¹
L spindle motor	18.5/15kW (op.35/26/22kW · 15/11kW Wide range)		
R spindle motor	11/7.5kW (op. 15/11kW 18.5/15kW)		

Upper turret

Number of turrets	1
Type of turret / Number of indexing pos.	Dodecagonal drum turret / 24
Driven-tool spindle speed	6000min ⁻¹
Drive motor	5.5/3.7kW
Milling-tool / Number of driven-tool station	Individual rotation / 12

Lower turret

Number of turrets	1
Type of turret / Number of indexing pos.	Dodecagonal drum turret / 24
Driven-tool spindle speed	6000min ⁻¹
Drive motor	5.5/3.7kW
Milling-tool / Number of driven-tool station	Individual rotation / 12

General

Machine dimension (L × W × H)	4,059mm × 2,314mm × 2,225mm
Machine Weight	8,700kg

WT-250II

48 stations

High-rigidity turret

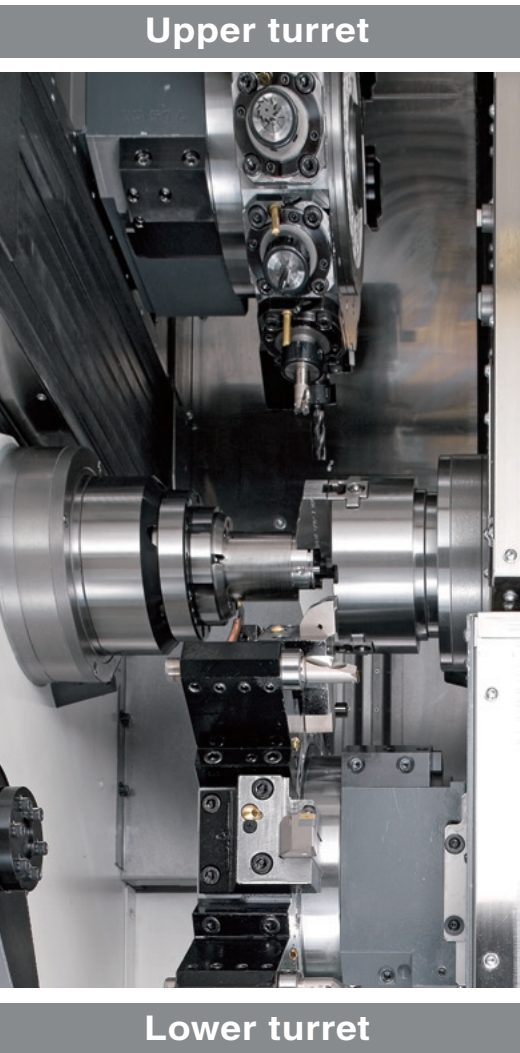

Upper turret

Lower turret

Bar capacity ϕ 65mm	Bar capacity ϕ 65mm	Bar capacity ϕ 65mm
Spindle motor 18.5 / 15kW 130.9 / 106.1N·m 4500min ⁻¹	Spindle motor 26 / 22kW 183.9 / 155.6N·m 4500min ⁻¹	Spindle motor 15 / 11kW 225.0 / 165.0N·m 4500min ⁻¹
C-axis C-axis synchronous control	Option	
Standard		

Dodecagonal / 24-station

- ◆ Number of driven-tool stations : 12
- ◆ Servo-driven turret

Milling	5.5 / 3.7kW 24.0 / 16.0N·m 6000min ⁻¹
Y-axis stroke \pm31mm	
Standard	



Larger window ensures better visibility

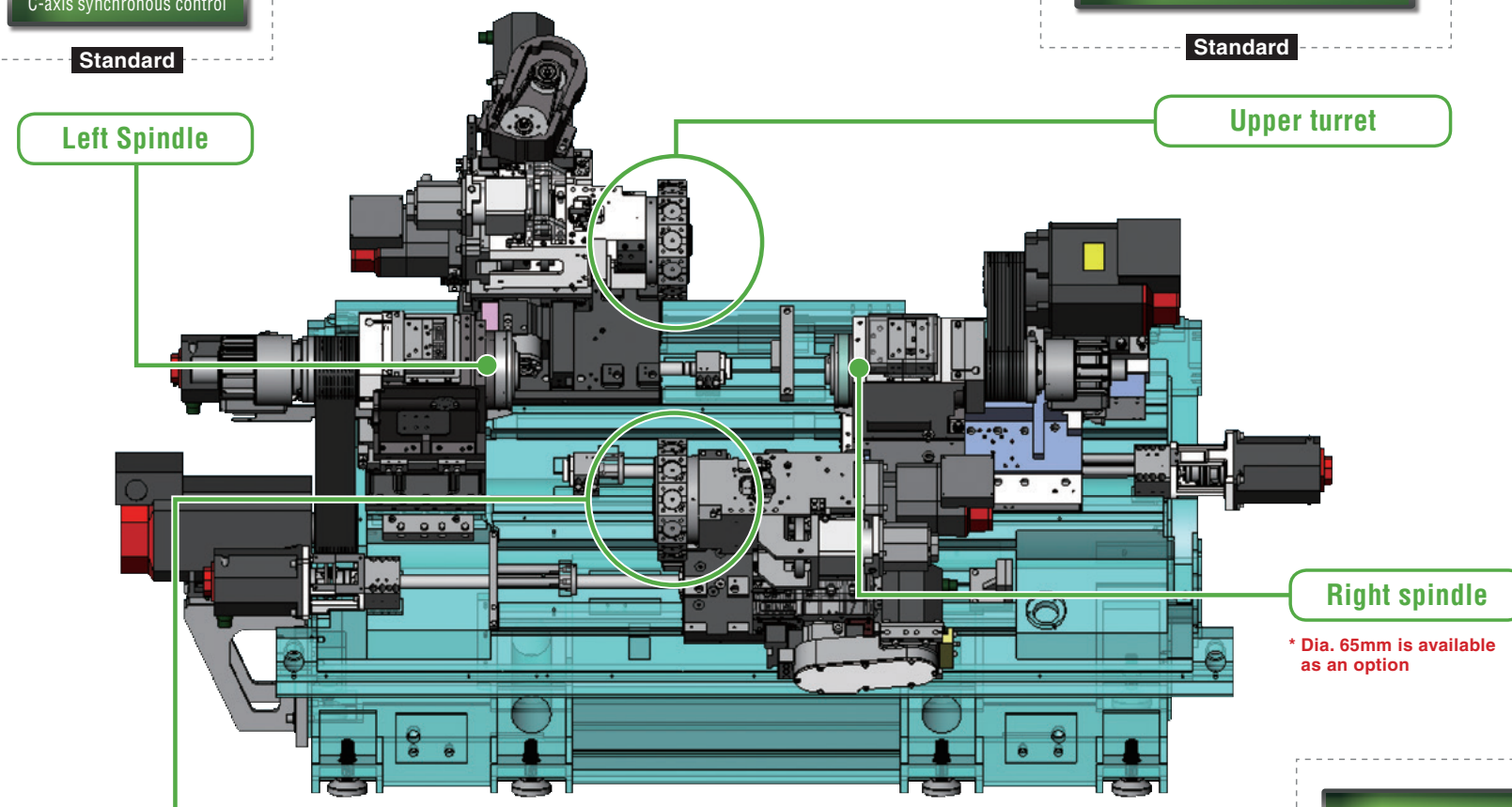

Left Spindle

Upper turret

Right spindle

* Dia. 65mm is available as an option

Lower turret

Dodecagonal / 24-station

- ◆ Number of driven-tool stations : 12
- ◆ Servo-driven turret

Milling	5.5 / 3.7kW 24.0 / 16.0N·m 6000min ⁻¹
----------------	--

* Milling motor speed is 3600min⁻¹ for ϕ 65mm right spindle bar capacity

Standard

Bar capacity ϕ 51mm
Spindle motor 11 / 7.5kW 77.8 / 53.1N·m 5000min ⁻¹
C-axis C-axis synchronous control
Standard

Bar capacity ϕ 51mm	Bar capacity ϕ 51mm
Spindle motor 15 / 11kW 106.1 / 77.8N·m 5000min ⁻¹	Spindle motor 18.5 / 15kW 120.4 / 97.7N·m 5000min ⁻¹
Option	

- Wide box-type side-ways on X, Z and Y-axes.
- 45 degrees slant bed structure with high rigidity torque tube and smooth chip disposal
- Dodecagonal / 24-station upper and lower turrets
- Dia. 210mm (8inch) chucks for left and right hand side spindles

Parts catcher G		Option
Method	Swing hand	
Workpiece size	Diameter [mm]	ϕ 65
	Length [mm]	200
	Weight [kg]	3
Cycle time [sec.]	6	
Ejecting method	Belt conveyor & Chute	



Part	JOINT
Category	Aircraft
Cycle time	8min 15sec.
Material	SUS303
Raw part dimension	D65mm Bar stock (FINISHED 80mm)



- | | | | | |
|--|---|---|---|---|
| <ul style="list-style-type: none"> ● Type :DWLNR2525M08 ● Diameter :65-45mm ● Rpm :1132min⁻¹ - 784min⁻¹ ● Feed :0.3mm/rev ● Cutting speed :160m/min ● Machining Time :75sec. | <ul style="list-style-type: none"> ● Type :TAFS3700F40 ● Diameter :37mm ● Rpm :1300min⁻¹ ● Feed :0.12mm/rev ● Cutting speed :150m/min ● Depth :24mm ● Machining Time :13sec. | <ul style="list-style-type: none"> ● Type :WX-PNC 16X42 P1.5-INT ● Diameter :16mm ● Rpm :800min⁻¹ ● Feed :0.06mm/rev ● Cutting speed :40m/min ● Machining Time :55sec. | <ul style="list-style-type: none"> ● Wedge :6mm ● Depth :3mm ● Length :32.5mm ● Type :N50-6814 ● Diameter :39mm ● Rpm :0 ● Feed :30m/min ● Cutting speed :3m/min ● Machining Time :84sec. | <ul style="list-style-type: none"> ● Type :EX-GDN0.5 ● Diameter :0.5mm ● Rpm :6000min⁻¹ ● Feed :0.015mm/rev ● Cutting speed :9.4m/min ● Deep :3.5mm ● Machining Time :25sec. |
|--|---|---|---|---|

Complete Control

A wide variety of parts can be machined from bar, shafts, forgings or castings. The highest productivity can be achieved with the newest technology in multitasking, all in a compact floor space.

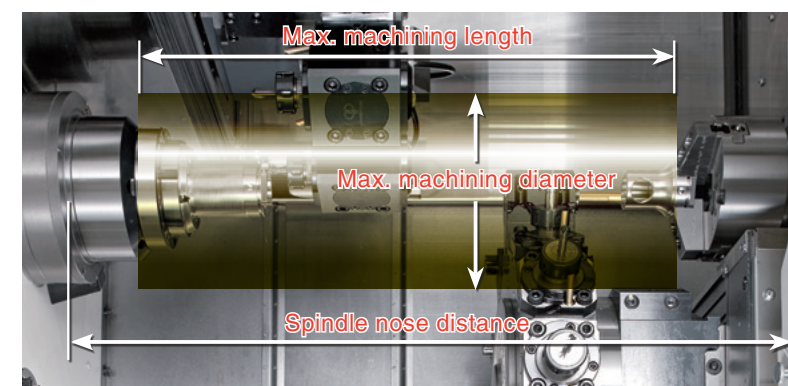
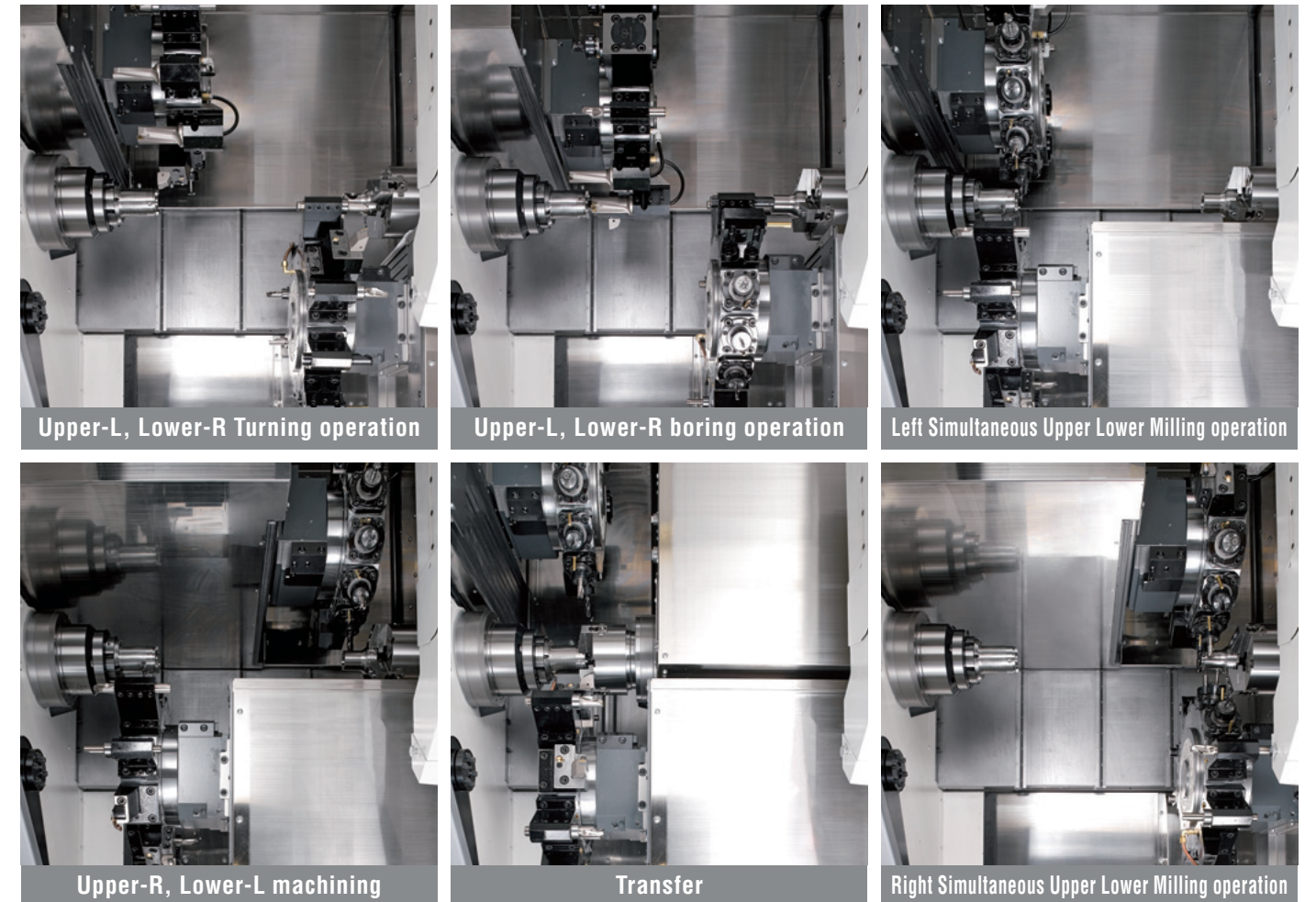

Max. machining length — **555mm**
 Max. machining diameter — **φ250mm**
 Spindle nose distance **Max. 885mm**
Min. 265mm

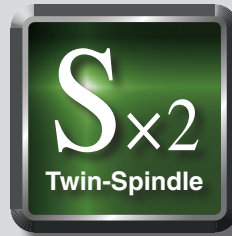

WT-250II

Cycle time reduced through simultaneous machining on Left and Right hand spindles.



L Spindle motors

Standard
Rotating speed : 4,500min⁻¹ 18.5/15kW φ65

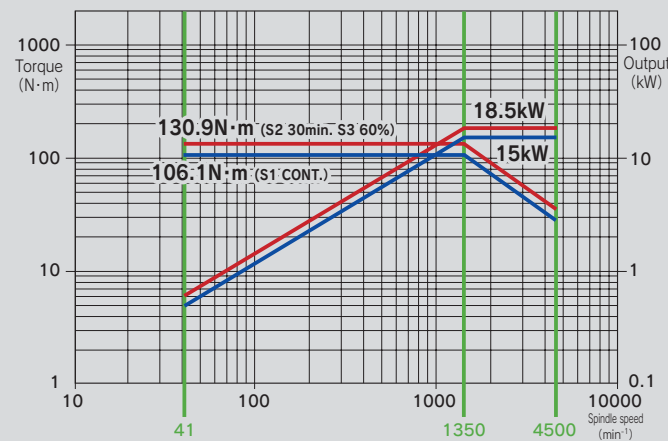

Option
Rotating speed : 4,500min⁻¹ 26/22kW φ65

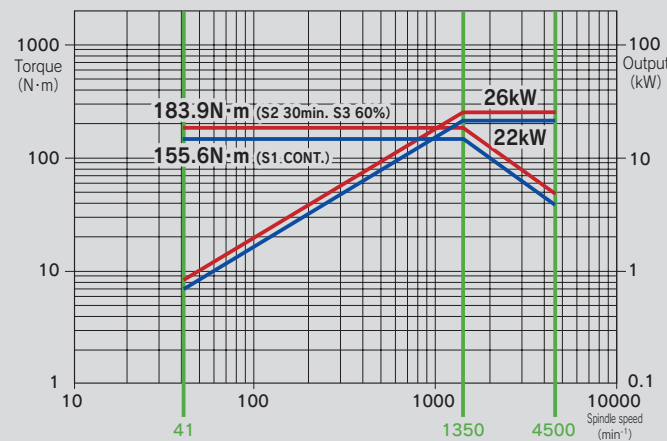

Option
Rotating speed : 4,500min⁻¹ 15/11kW (Wide range) φ65

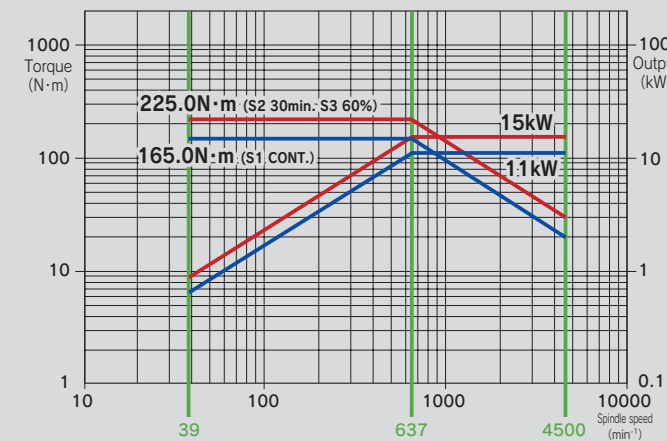

Milling-tool motor

Standard
Rotating speed : 6,000min⁻¹

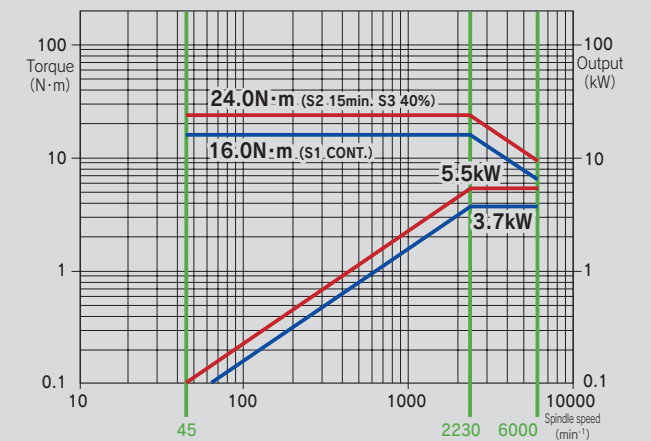

● When bar capacity φ 65mm is equipped on Right spindle (option), max rotation speed of driven tools will be 3,600min⁻¹

R Spindle motors

Standard
Rotating speed : 5,000min⁻¹ 11/7.5kW φ51

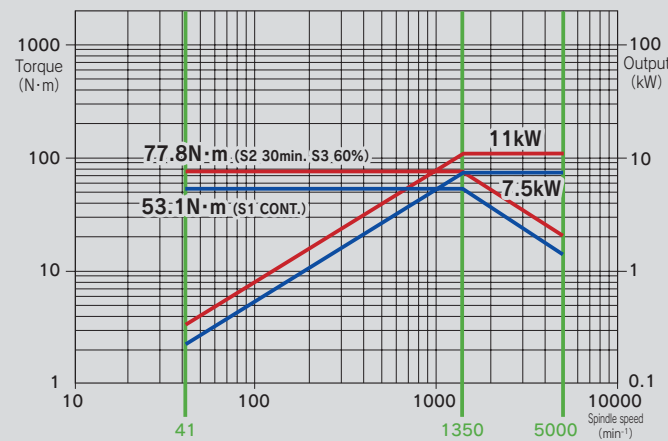

Option
Rotating speed : 5,000min⁻¹ 15/11kW φ51

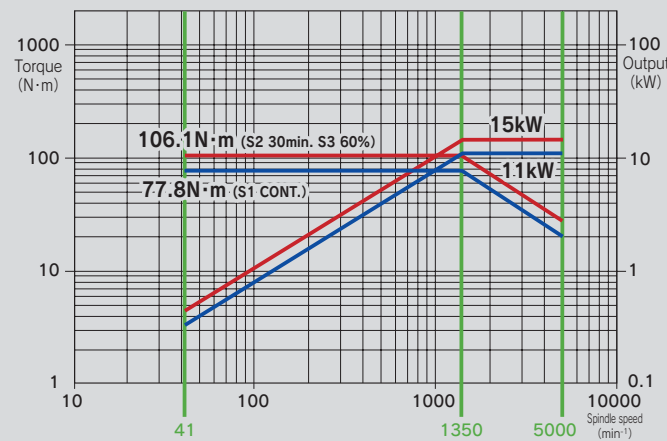

Option
Rotating speed : 5,000min⁻¹ 18.5/15kW φ51

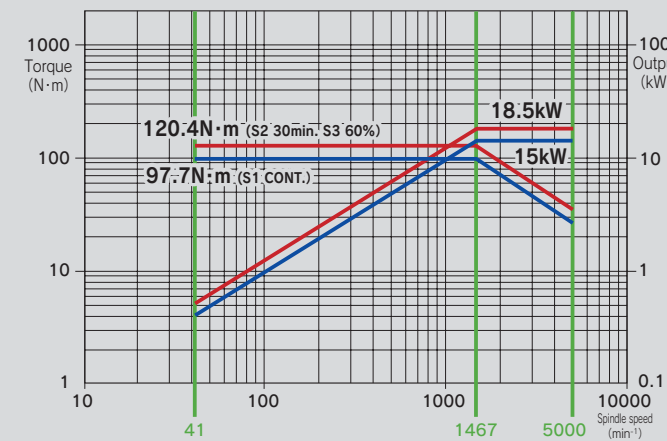

Option
Rotating speed : 3,600min⁻¹

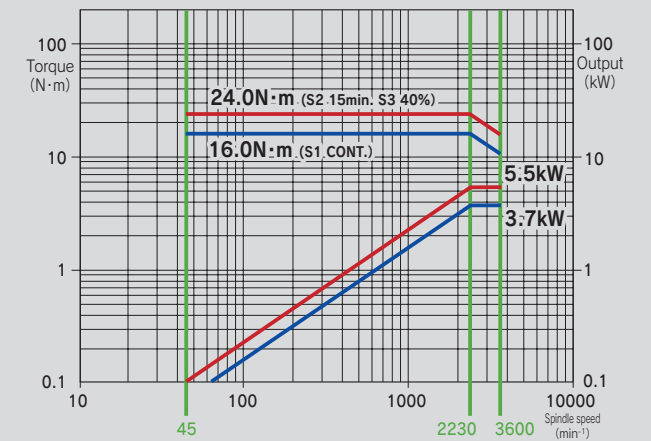

NT Smart X

Full Operator Support from Ease of Use to Reliability.

3D Smart PRO
Original Menu screen
Voice Guidance
Multiple-Touch screen
Windows 8.1

Main features of NT SmartX

Standard

- NT Work Navigator
- Airbag (Overload detection)
- NT Nurse function
- Status Display Function
- Setup Display
- Trouble Guidance
- Productivity Function
- Warm up Function
- Tool spindle loading Operation function
- Parts Catcher G Operation Function
- NT Machine Simulation
- NT Collision Guard
- NT Multitasking Office (op.)
- NT Thermo Navigator AI
- NT Smart Sign
- Digital Chuck interlock
- One touch MDI function



Cut in check

- 19 inch color LCD touch panel
- PC memory 8 GB
- QWERTY keyboard
- Windows 8.1
- Touch pad
- USB 2.0 Port x 2

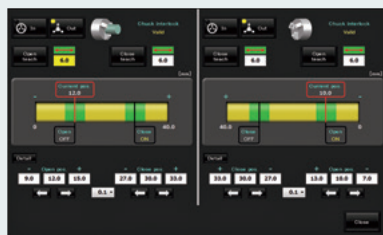

Digital Chuck Interlock

Set the detection position of open end and closed end of chuck arbitrarily. The chuck open / close position is set on the NT Smart X screen. Setup time and machining cycle time are reduced.

One Touch MDI

This function is to register in advance frequently used cycle programs such as home position return and tool exchange, and call with one touch.

Reduce programming and setup time, while eliminating input errors.



NT Smart Sign

Nakamura-Tome IoT software

※Please refer to the NT Smart Sign exclusive catalog for details.

Monitoring



Real Time Monitoring of machine running conditions, in addition to visualizing alarm history and past events.

Data Input / Output



Input and output programs, tool data and other machine data from the monitoring PC.

Diagnosis

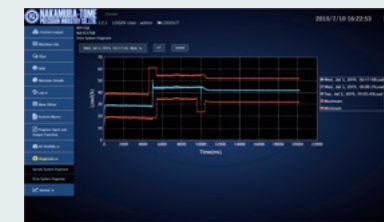

Diagnose problems with the machine servo drives and spindle drives, using a dedicated program.

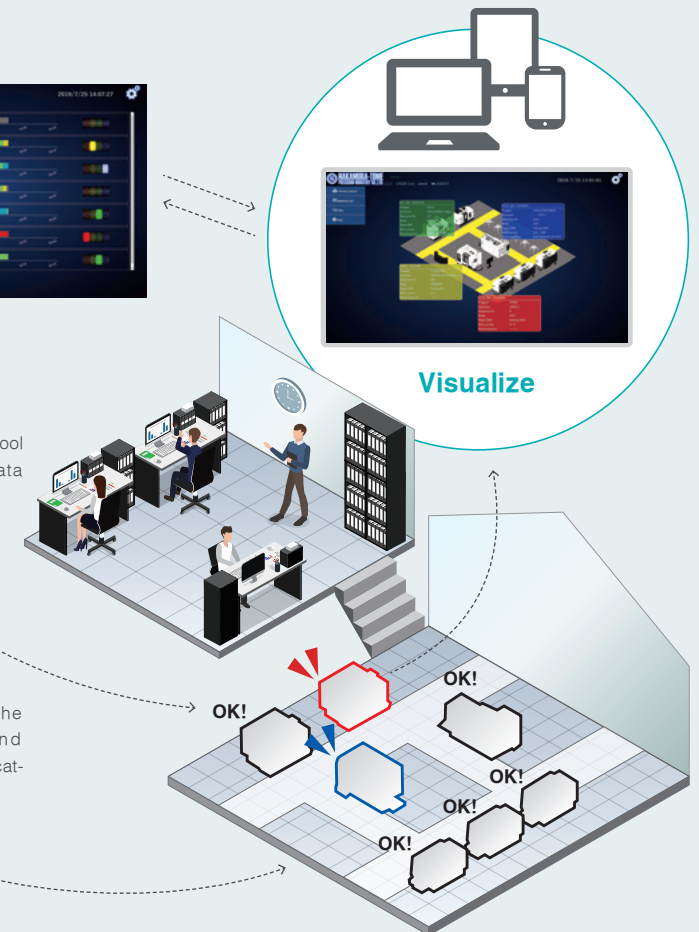

NT Thermo Navigator AI

Thermal Growth Compensation using AI.

Compensation model built using AI machine learning.

Powered by AI

Time and measured dimension data are input into a dedicated AI Learning software, to build an optimized thermal growth compensation model.



High Precision Thermal Growth Compensation

The compensation value is calculated from acquired data. The more data is input, the more accurate is the compensation value.

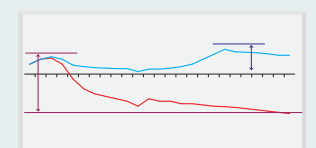

— Pre-correction thermal displacement data
— Thermal displacement data after correction

- ① Time
- ② Measured Dimensions
- ③ Retrieval of Wear Offset Data

Acquired Data analyzed with NT Thermo Navi AI

Feedback

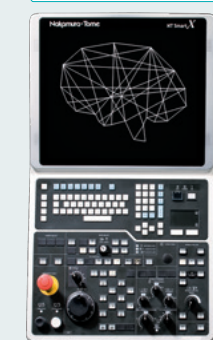

Standard for NT Smart X

Double safety features for maximum protection

NT Machine Simulation / NT Collision Guard + Airbag

The machine is protected with dual safety features: "NT Machine Simulation / NT Collision Guard" prevent collision beforehand, and the "Airbag Function" minimize damage to the machine in case of collision.

NT Machine Simulation

NT Machine Simulation is for Virtual Collision Checking of NC Programs without axis movement.



By checking in advance the chuck and the tool, the tool and the cover, etc. and checking the machining process etc., the risk of a machine collision when actually moving the machine can be reduced.

It can simulate while checking the remaining movement amount and modal information

It can override the settings for fast feed and cutting feed individually. Simulation by process, single feed is possible.

By process
Single feed

Image shown here is of a 2-turret machine

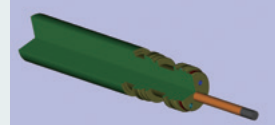

During part simulation, several display screens are available, such as tool view, turret view or machine view.

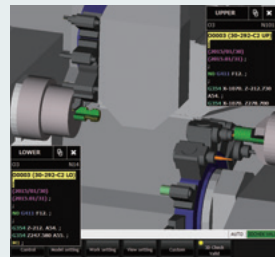

It can show or hide the machining program. In addition, the display of the program is color-coded for each word, and this color scheme can be set arbitrarily from the option setting screen.

NT Collision Guard

Preventive safety technology - Machine collisions are avoidable!



Available in automatic mode or in manual mode. Using registered 3D models of machine, chucks, tools, holders and parts, machine collisions can be monitored and prevented in real time during automatic, manual or jog movements.

Even turret indexing is monitored to prevent collisions, drastically reducing collision risks, especially during machine setup.

Tool 3D Model setup was simplified.

After turret rotation, the tool being indexed is read from the program, and the corresponding tool 3D model is automatically displayed, or can be changed from a pre-registered tool 3D Model list if necessary.

Image shown here is of a Tool spindle machine

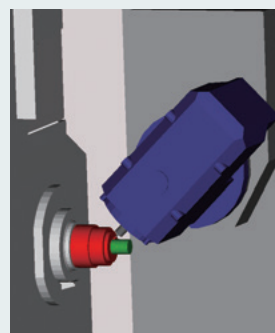
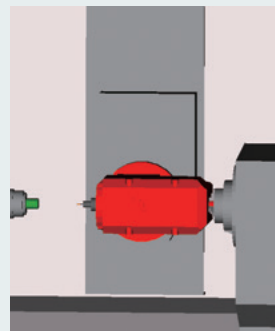

Airbag (Overload detection)

Compared to other machines, Nakamura-Tome machine will not break after the slightest collision. The "Airbag Function" minimizes the damage that may occur during a collision.

If a machine collision occurs, there is good reason to be assured: Airbag !

Barrier?
Even with barrier function, machine collisions may occur

When the machine collision, there is no reason to panic. Nakamura-Tome is...

The Airbag (Overload detection) of the machine tool greatly reduces the impact of a collision, and protects the machine.

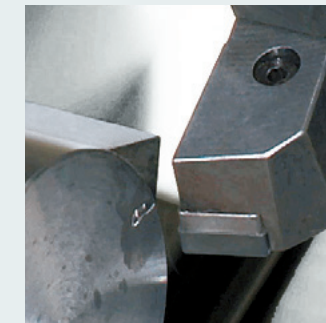
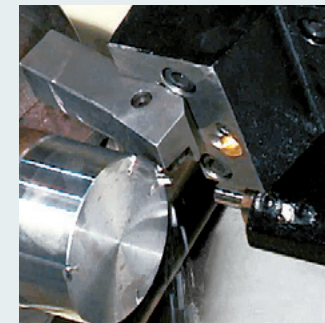

Without Airbag

Machine will not be stop immediately. The slide continues to move even after collision.

With Airbag

Retraction within 0.001 sec

Crash !
Within 1 milliseconds after the crash, servo motor-feeding direction is reversed and the machine stops in EMG mode.



▲Video

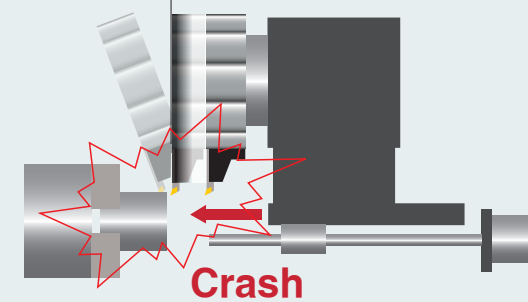

* This feature does not mean zero impact

NT Work Navigator

X Y Z B C

A new upgrade makes it possible to navigate with the X and Y-axes. Many parts with irregular outer surfaces, requiring coordinate recognition with X or Y-Axis, become within the range of NT Work Navigator.

Advanced NT Work Navigator !

No fixtures required

Machining parts with non-round shapes, such as forgings or castings requires that the raw part coordinates be recognized by the CNC control. In order to achieve this without requiring extra cost or additional options, the NT Navigator is used. It works just by touching the part with a simple inexpensive probe (mostly round bar mounted on a tool holder) and using the torque control feature of the servo-motor, which is to record required coordinates in the CNC. The NT Navigator is a cost cutting feature in multitasking machines, eliminating the need for positioning fixtures and special clamping devices.

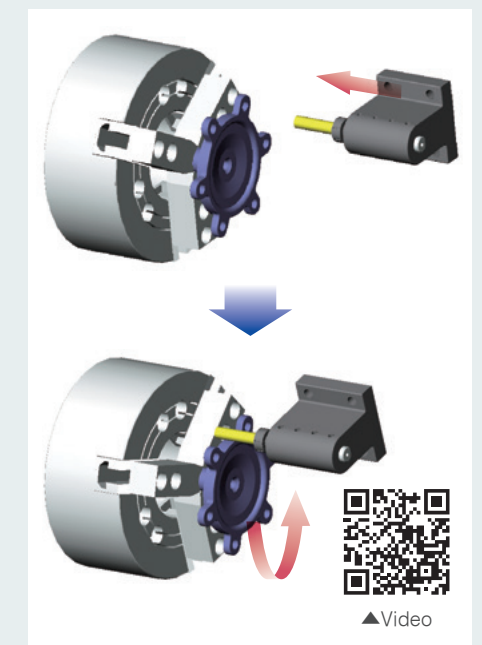

▲Video

Slide Travel Range

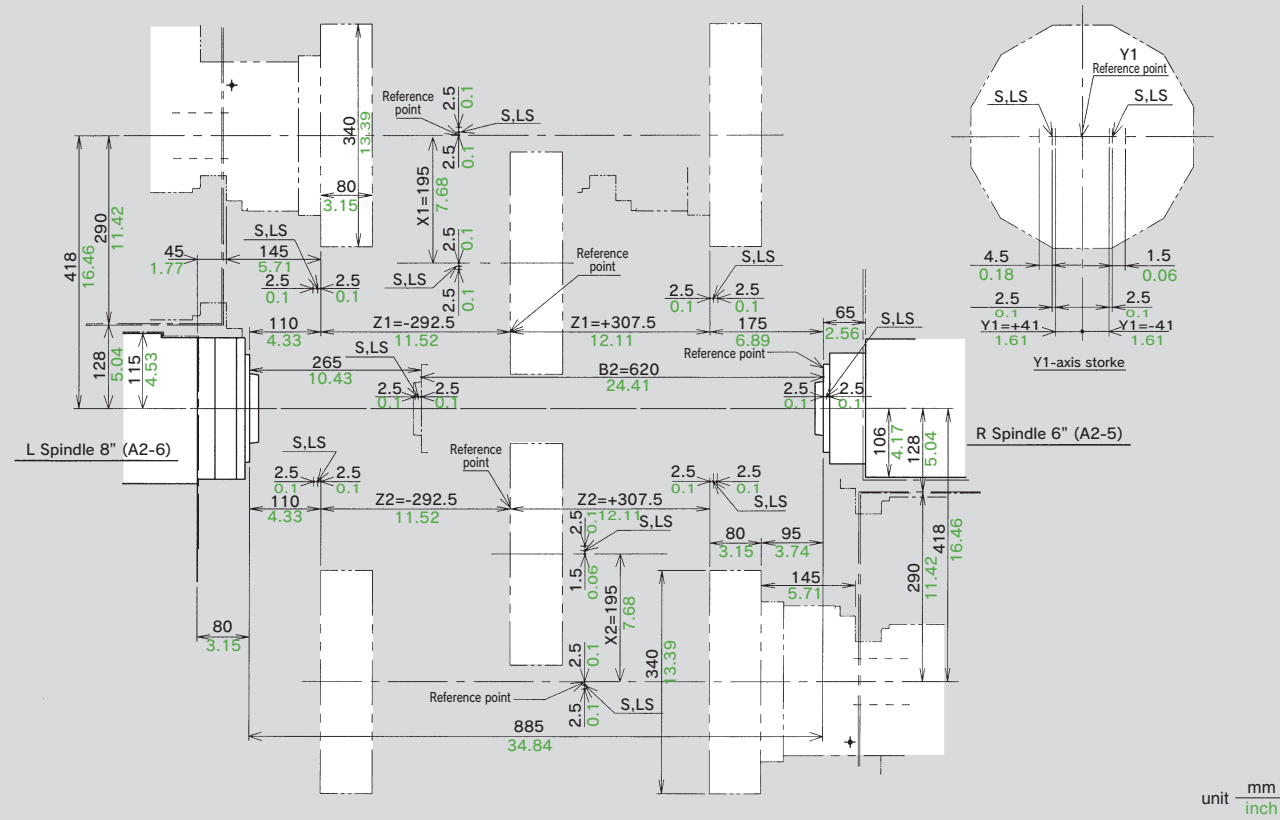

Tool Interference

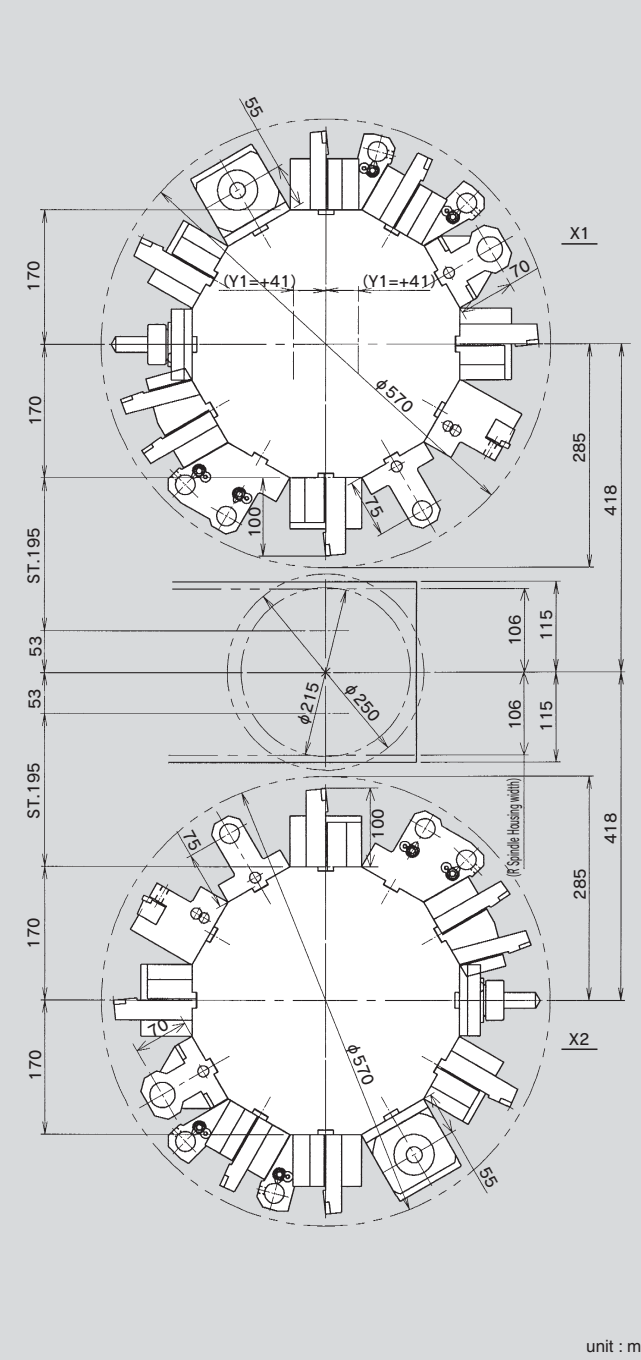

Maximum Tool Diameter

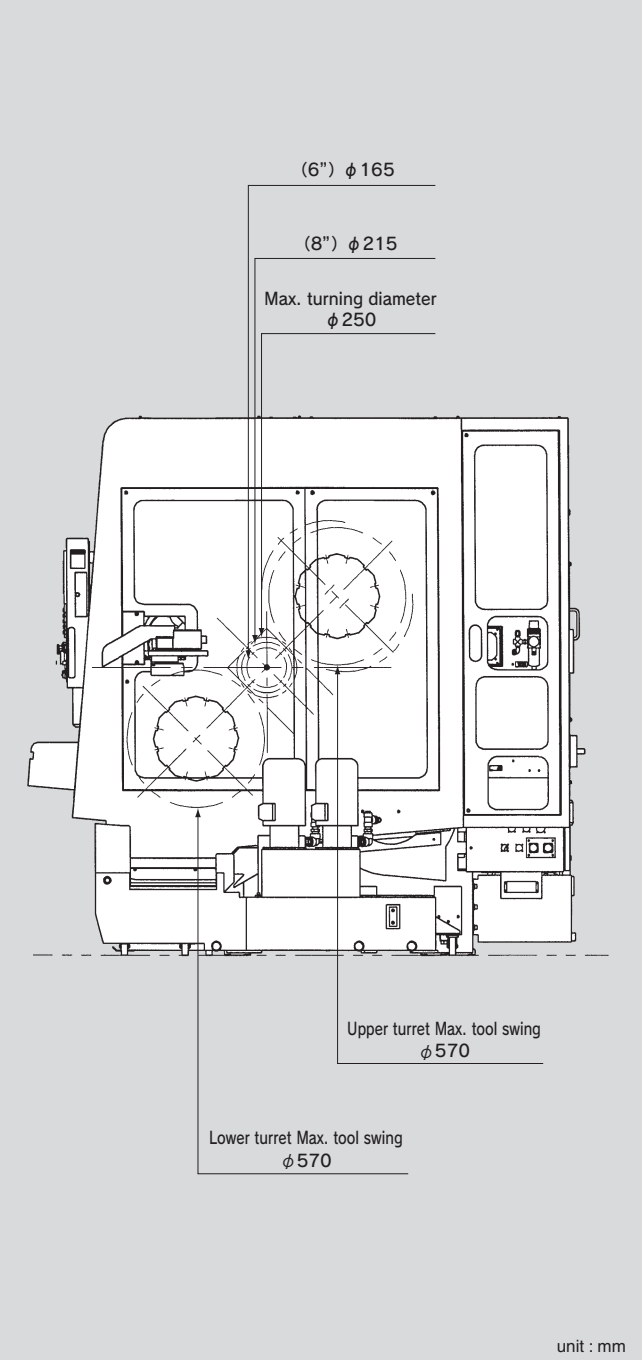

Machine Dimensions

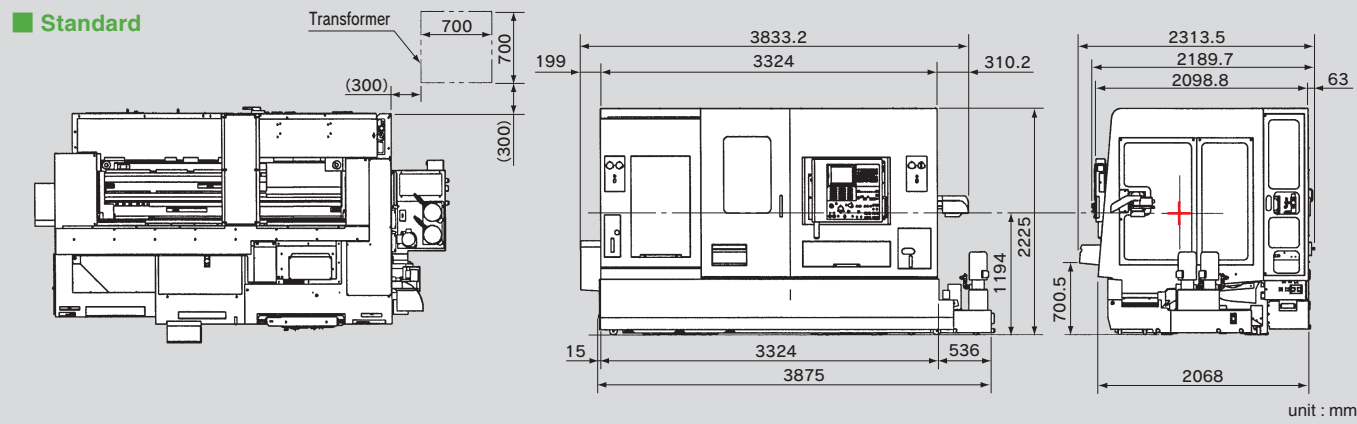

Multi-Turret Type Multitasking Machine WT Series



WT-100



WT-150II



WT-250II



WT-300

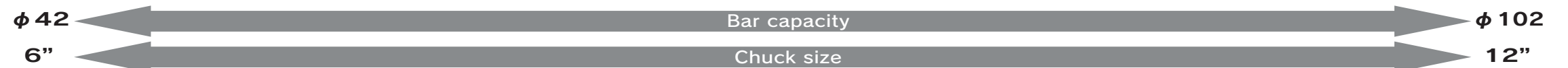

Tooling System Diagram

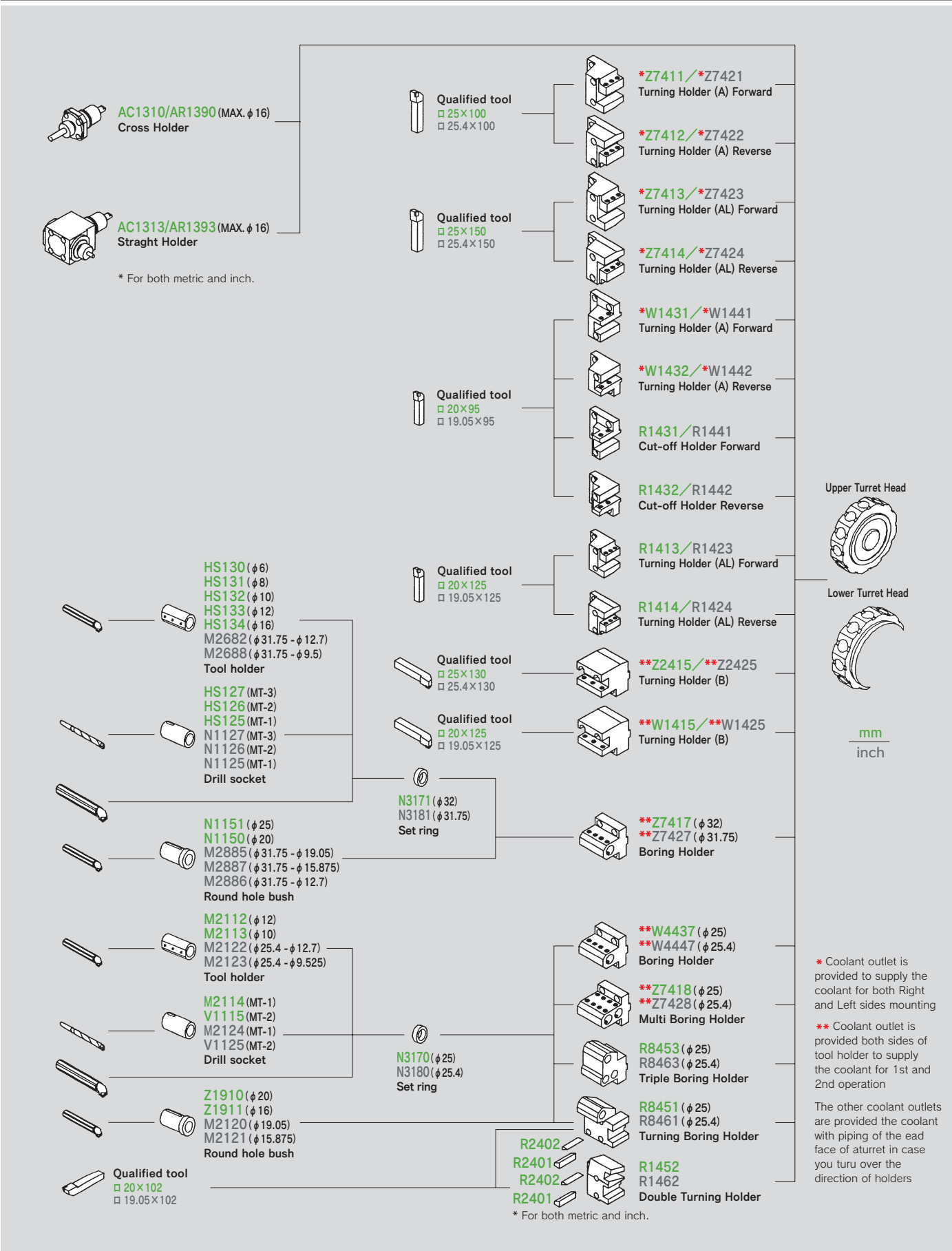

Machine Specification

Capacity		
Max. turning diameter	250mm	
Standard turning diameter	100mm	
Distance between centers	max. 885mm / min. 265mm	
Max. turning length	555mm	
Bar capacity L / R	L : 65mm R : 51mm, 65mm (op.)	
Chuck size	215mm (8") / 165mm (6")	
Axis travel		
Slide travel (X1 / X2)	195mm / 195mm	
Slide travel (Z1 / Z2)	600mm / 600mm	
Slide travel (Y1)	±41mm *Upper turret	
Slide travel (B2-axis)	620mm	
Rapid feed X1 / X2	16m/min	
Rapid feed Z1 / Z2	30m/min	
Rapid feed B2 axis	30m/min	
Rapid feed Y1	6m/min	
Left and Right spindles		
	L : 65mm	R : 51mm R : 65mm (op.)
Spindle speed	4500min ⁻¹	5000min ⁻¹ 4500min ⁻¹
Spindle speed range	Stepless	Stepless Stepless
Spindle nose	A2-6	A2-5 A2-6
Hole through spindle	80mm	63mm 80mm
I.D. of front bearing	110mm	90mm 110mm
Hole through draw tube	66mm	52mm 60mm
C-axis		
Least input increment	0.001°	
Least command increment	0.001°	
Rapid index speed	600min ⁻¹	
Cutting feed rate	1 - 4800°/min	
C-axis clamp	Disk clamp	
C-axis engagement time	1.5sec.	
Upper / Lower turret		
Type of turret	Dodecagonal drum turret	
Number of Tool stations	24	
Number of Indexing positions	24	
Tool size (square shank)	□ 25mm	
Tool size (round shank)	φ 32mm	
Milling tools		
	L65mm / R51mm	R65mm
Rotary system	Individual rotation	
Spindle speed	6000min ⁻¹	3600min ⁻¹ *1
Spindle range	Stepless	
Number of driven-tool stations	12×2	
Collet size	AR25	
Holder type and tool size	Straight holder φ 1mm - φ 16mm Cross holder φ 1mm - φ 16mm	
Drive motor power and torque		
L-spindle	Option	18.5/15kW (131/106N·m)
	Option	26/22kW (184/156N·m)
	Option	15/11kW [Wide range] (225/165N·m)
R-spindle	Option	11/7.5kW (78/53N·m)
	Option	15/11kW (106/78N·m)
	Option	18.5/15kW (120/98N·m)
Milling-tool spindles	5.5/3.7kW (24/16N·m)	
General		
Machine height	2225mm	
Floor space	4059mm × 2314mm	
Floor space	4838mm × 2518mm *2	
Machine weight	8700kg	
Power source		
Power supply	54.8kVA *3	
Air supply	150 - 200NL/min, 0.5 - 0.7MPa	

*1 Some tool holders have a max. 3,600min⁻¹.

*2 When with chip conveyor.

*3 Depends on equipped options and peripherals.

● Safety devices such as various interlocks, fences for robotics, auto loading device, work stocker, automatic fire extinguisher etc. are available as options which can be included in your purchase package. Please contact our local distributor and dealer for your specific requirements.

Precautions about the use of cutting coolant

Synthetic Coolants are Damaging to Machine Components. Concerning the use of cutting fluids, cautions have to be taken on the type of coolant being used. Among coolants available in the market, some types are damaging to machine components and should be avoided. Typical damages are turcite wear, peeling of paint, cracking and damage to plastics and polymers, expansion of rubber parts, corrosion and rust build up on aluminum and copper. To prevent such damages, coolants that are synthetic, or containing chlorine have to be avoided. Machine warranty terms do not apply to any claims or damage arising from the use of improper coolant.

Control Specification

Items	
Control Type	FANUC 31i-B 2-PATH
Controlled axes	
Controlled axes	5-axes
Simultaneously controlled axes	2-axes (Upper X, Z, C) + 3 axes (Lower X, Z, C, B)
Simultaneously controlled axes with milling	3-axes (Upper X, Z, C) + 4 axes (Lower X, Z, C, B)
Simultaneously controlled axes with Y-axis (op.)	4-axes (Upper X, Z, C, Y) + 4 axes (Lower X, Z, C, B)
Input command	
Least input increment	X, Z, Y, B2 : 0.001mm / 0.0001inch (diameter for X-axis), 0.001deg.
Least command increment	X : 0.0005mm, Z : 0.001mm, C : 0.001°, B2 : 0.001mm, Y : 0.001mm
Max. programmable dimension	±999999.999mm / ±39370.0787in, ±99999.999°
Absolute / incremental programming	X, Z, C, Y, B2 (absolute only for B2) / U, W, V, H
Decimal input	Standard
Program code	EIA / ISO automatic recognition
Inch / Metric conversion	G20 / G21
Programmable data input	G10
Feed function	
Cutting feed	feed / min X : 1 - 4800mm/min, 0.01 - 188inch/min Z : 1 - 4800mm/min, 0.01 - 188inch/min C : 1 - 4800degree/min B2 : 1 - 4800mm/min, 0.01 - 188in/min feed/rev : 0.0001 - 4800.0000mm/rev 0.000001 - 50.00000in/rev
Dwell	G04
Feed per minute / Feed per revolution	G98 / G99
Thread cutting	G32F
Thread cutting retract	Standard
Continuous thread cutting	Standard
Variable lead threading	G34
Handle feed	Manual pulse generator 0.001/0.01/0.1mm, °(per pulse)
Automatic acceleration / deceleration	Standard
Linear acceleration / deceleration after cutting feed interpolation	Standard
Rapid feed override	F0/25/100% (changeable to every 10% by switch)
Cutting feed-rate override	0 - 150% (each 10%)
AI contour control	G5.1
Program memory	
Part program storage length	256Kbyte (640m)
Part program edit	delete, insert, change
Program number search	Standard
Sequence number search	Standard
Address search	Standard
Number of registrable programs	500programs
Program storage memory	backed up by battery
Multiple program simultaneous editing	Standard
DNC operation through memory card	Standard (Only one turret can access memory card at a time) (not including memory card)
Extended part program editing	Standard
Operation and display	
Operation panel : Display	19" color LCD
Operation panel : Keyboard	Separate type MDI unit (standard keys)
Program support	
Circular interpolation R programming	Standard
Direct drawing dimension programming or Chamfering / Corner R	Standard (Direct drawing dimension programming is standard)
Canned cycle	G90, G92, G94
Multiple repetitive canned cycle	G70 - G76
Multiple repetitive canned cycle II	Standard
Canned cycle for drilling	G80 - G89
Polar coordinate interpolation	Standard (used for C axis control from Lower)
Cylindrical interpolation	Standard (used for C axis control from Lower)
Synchronized mixture control	Standard (used for C axis control from Lower)
Sub program	Standard
Balance cut	G68, G69
Custom macro	Standard
Addition to custom macro common variables	Standard (After addition, #100 - #199, #500 - #999)
FS15 tape format	Standard
Luck-bei II	Standard
Abnormal load detection function	Standard
NT Work Navigator	Standard (not including contact bar)
NT Nurse	Standard
NT Collision Guard	Standard
Mechanical support	
Rigid type	Standard
Spindle synchronised control	Standard
C axis synchronised control	Standard
Spindle orientation	Standard
NT-IPS	
O/S	Windows XP Embedded
Pointing device	Touch pad



NAKAMURA-TOME PRECISION INDUSTRY CO., LTD.

<http://www.nakamura-tome.co.jp>

Netsuno 15, Hakusan city, Ishikawa, 920-2195 Japan

Phone : +81 76 273 8100 Fax : +81 76 273 4312

E-mail : nt-jpn@nakamura-tome.co.jp

- This catalog was published in September, 2019. Specifications, illustrations and data given herein are subject to change without notice.
- The products in this catalog are controlled based on Japan's "Foreign Exchange and Foreign Trade Law". The export of the products are subject to an export license by the Japanese government.