



Matsuura

URL : <http://www.matsuura.co.jp/>

E-MAIL : webmaster@matsuura.co.jp

MATSUURA MACHINERY CORPORATION

1-1 Urushihara-cho Fukui City 910-8530, Japan

TEL : +81-776-56-8106 FAX : +81-776-56-8151

MATSUURA EUROPE GmbH

Berta-Cramer-Ring 21

D-65205 Wiesbaden-Delkenheim, Germany

TEL : +49-6122-7803-80 FAX : +49-6122-7803-33

URL : <http://www.matsuura.de/>

E-MAIL : info@matsuura.de

MATSUURA MACHINERY Ltd.

Gee Road, Whitwick Business Park, Coalville Leicestershire, LE67

4NH, England

TEL : +44-1530-511-400 FAX : +44-1530-511-440

URL : <http://www.matsuura.co.uk/>

E-MAIL : sales@matsuura.co.uk

MATSUURA MACHINERY GmbH

Berta-Cramer-Ring 21

D-65205 Wiesbaden-Delkenheim, Germany

TEL : +49-6122-7803-0 FAX : +49-6122-7803-33

URL : <http://www.matsuura.de/>

E-MAIL : info@matsuura.de

ELLIOTT MATSUURA CANADA INC.

2120 Buckingham Road Oakville Ontario L6H 5X2, Canada

TEL : +1-905-829-2211 FAX : +1-905-829-5600

URL : <http://www.elliottmachinery.com/>

E-MAIL : sales@elliottmachinery.com

MATSUURA MACHINERY USA INC.

325 Randolph Ave., St.Paul, MN 55102, U.S.A.

TEL : +1-651-289-9700

URL : <http://www.matsuurausa.com/>

E-MAIL : info@matsuurausa.com

- Product specifications and dimensions are subject to change without prior notice.
- The photos may show optional accessories.

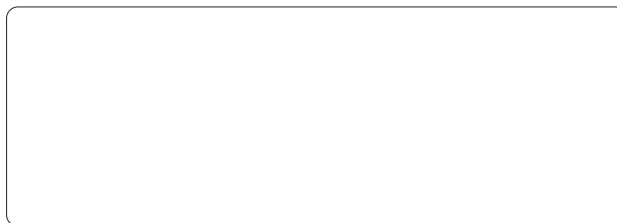

This product is subject to all applicable export control laws and regulations



FH-E2.0 201611 2000 BS

 **Matsuura**

Horizontal Machining Center

H.Plus-630

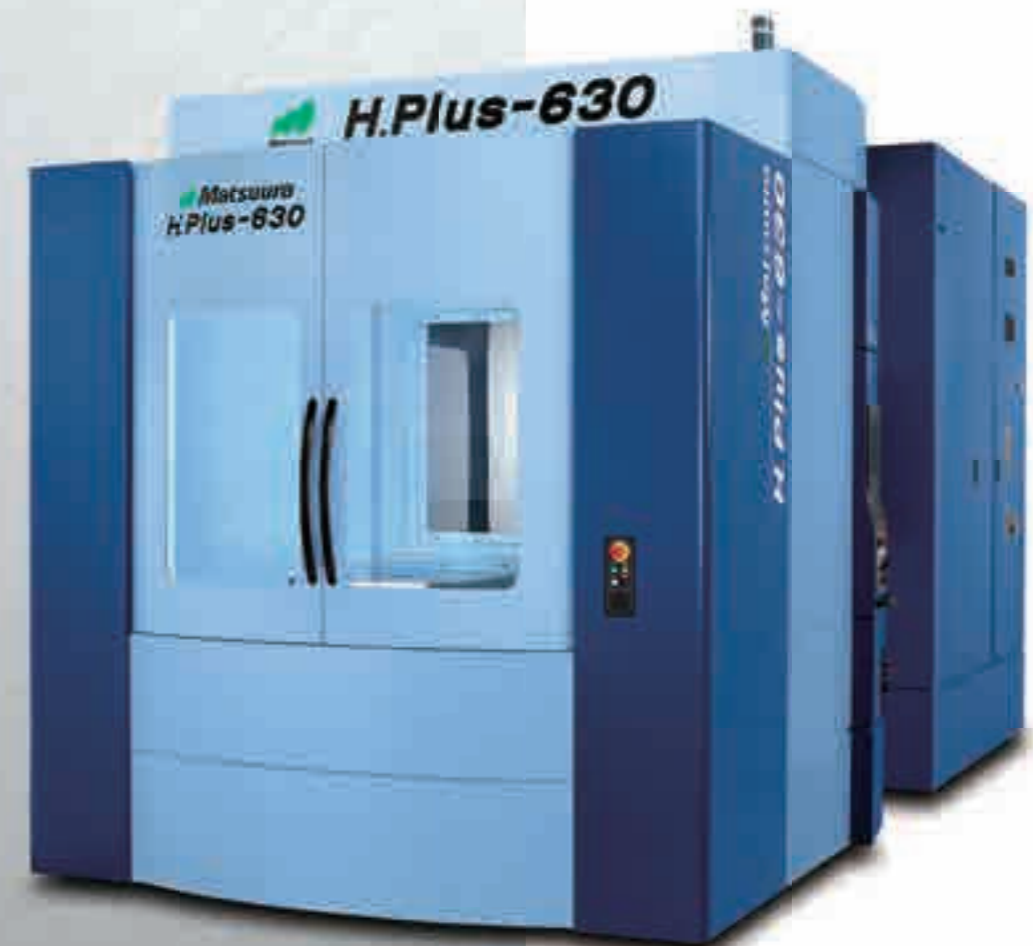

MAXIA
Innovation by  Matsuura

Mitsuura H.Plus-630

Updated and advanced to meet the challenges of today's manufacturers; the best in class just got better

Updated!

- Equipped with a new operation panel with a 15-inch touchscreen for improved operability and visibility.
- New Matrix tool changers-large capacity and high speed options.

Features

- 700 N·m high-torque spindle (10000 min⁻¹ Option)
- Workpiece size: $\phi 1050$ x H1115 mm, 1200 kg
- The B axis uses a DD motor (75 min⁻¹) for the fastest drive in the class.
- 60 m/min on X, Y and Z axes, the fastest in the class.

Max. Workpiece Size

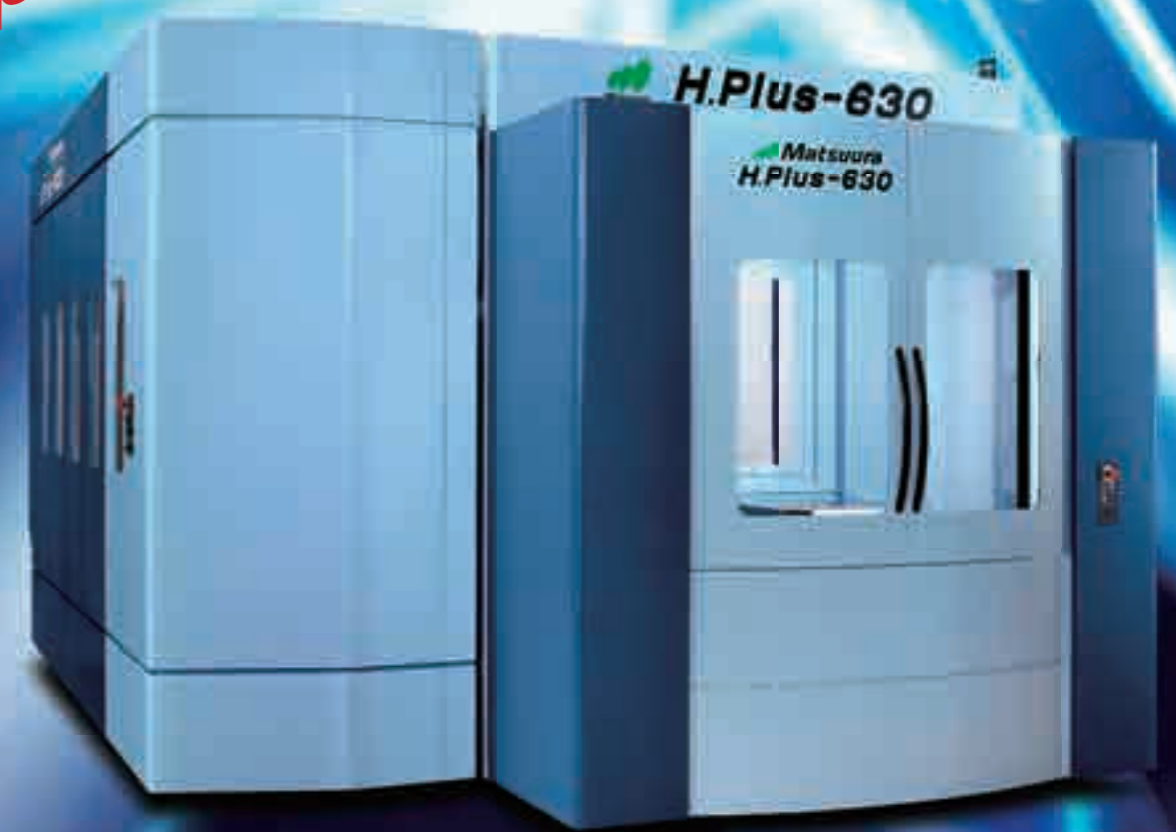
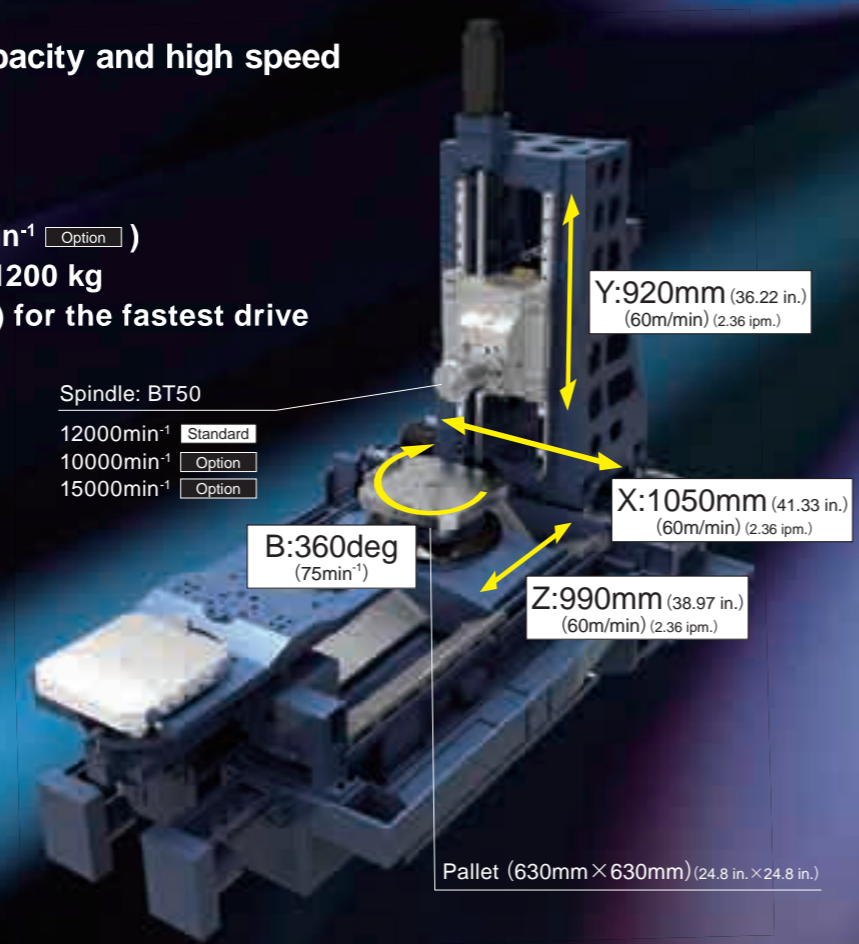
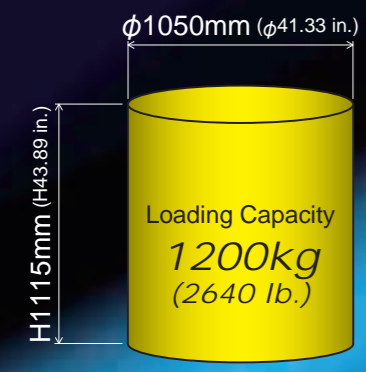

PC2
*120-tool type

MAXIA Spindles; Renowned for maximum performance and durability in even the most arduous machining environments

Choose from 3 handcrafted BT50 spindle types—designed, manufactured and tested in house at Matsuura.

Standard BT50 12000min⁻¹

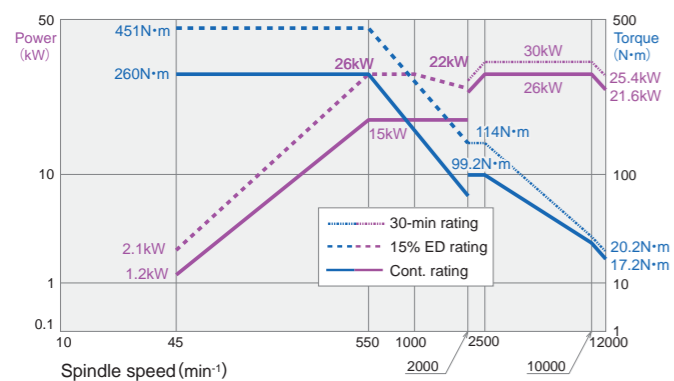

Option BT50 10000min⁻¹ High-torque type 700N·m

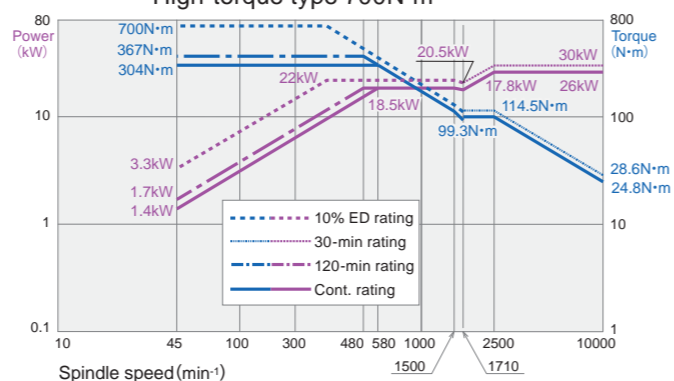

Option BT50 15000min⁻¹ High-speed type

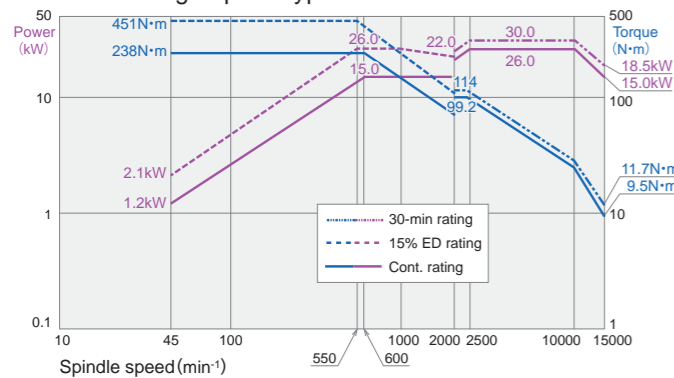

All manufacturing processes are handled in-house, from spindle design to machining, assembly and inspection.

Cutting test results (BT50 12000min⁻¹) Standard

Standard							(in.)					
	Workpiece material	Tool details	Cutting width Cutting depth	Spindle speed	Cutting feed rate	Cutting capacity		Workpiece material	Tool details	Spindle speed	Cutting feed rate	Cutting capacity
Facemill	Aluminum	Ø100mm (3.93) 4-flute	W=80mm (3.14) D=5mm (0.19)	5500 min ⁻¹	9000 mm/min (354.33)	3600 cc/min	Drill	Aluminum	Ø52mm (2.04)	1500 min ⁻¹	400 mm/min (15.74)	849 cc/min
	Steel	Ø125mm (4.92) 9-flute	W=90mm (3.54) D=7mm (0.27)	550 min ⁻¹	900mm/min (35.43)	567 cc/min		Steel	Ø52mm (2.04)	1500 min ⁻¹	220 mm/min (8.66)	467 cc/min
Endmill	Aluminum	Ø25mm (0.98) 2-flute	W=20mm (0.78) D=15mm (0.59)	12000 min ⁻¹	7000 mm/min (275.59)	2100 cc/min	Tap	Aluminum	M42 × P4.5	120 min ⁻¹	540 mm/min (21.25)	
	Steel	Ø25mm (0.98) 4-flute	W=3mm (0.11) D=40mm (1.57)	5500 min ⁻¹	6000 mm/min (236.22)	720 cc/min		Steel	M42 × P4.5	80 min ⁻¹	360 mm/min (14.17)	

* The data above are examples of actual results. Under different conditions, it may not be possible to achieve the data stated in this catalog.

Standard Feature; Direct Drive Rotary Indexing Table

Rotary Indexing Table Utilizing a DD Motor

The Direct Drive motor (75 min⁻¹) delivers high speed operation with unerring acceleration and precision. The non-contact design is low noise and maintenance free.



ADC (Automatic Acc. & Dec. Control) Automatic Acceleration and Deceleration Control Function

A function that automatically tunes the B-axis / Z-axis acceleration and deceleration according to the workpiece inertia is adopted (implemented during ATC operation). It reduces indexing time by up to 35%.

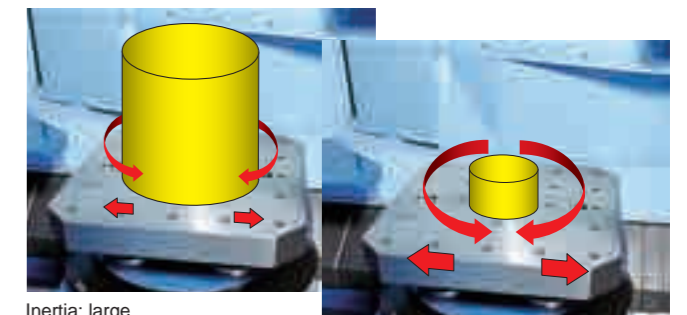

DCS (Dynamic Clamp System)

The key to shorter indexing times is the table clamping/unclamping time.

Matsuura's DCS function is the world's first revolutionary clamping system. The load level applied to the DD motor is monitored, and the table is clamped only when the load level has exceeded the setting value. The table remains unclamped even during machining as long as the load level is within the preset load range.

- Within the preset load range ⇒ Machining with the table unclamped (M21 and M22 skipped for light machining)
- Load range exceeding the setting value ⇒ Machining with the table clamped (M21 and M22 not skipped for heavy machining)

Light machining

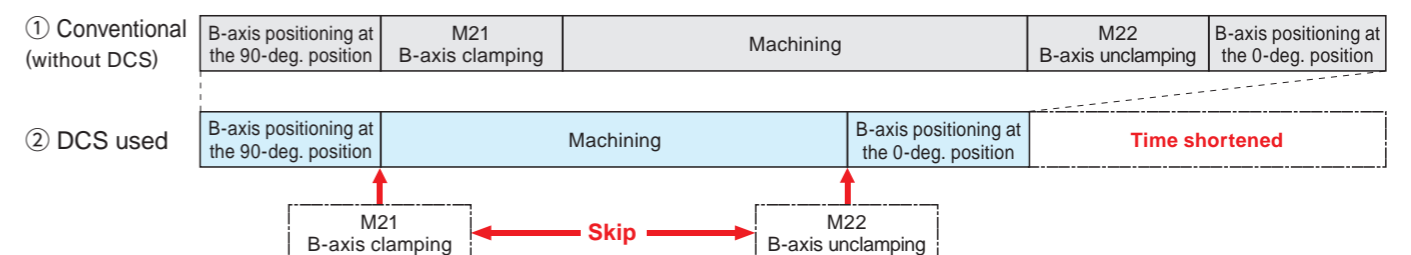

Expandable to Handle Prolonged Unmanned Operation

A wealth of multi-tool/multi-pallet options are available.



60-tool Drum Magazine

Standard

A servo-driven 60 tool capacity drum magazine is standard on the *H.Plus-630*. Compared to other ATC configurations of equal capacity on the market, this Matsuura design delivers a 50% reduction in operating noise & offers high speed & highly accurate indexing.

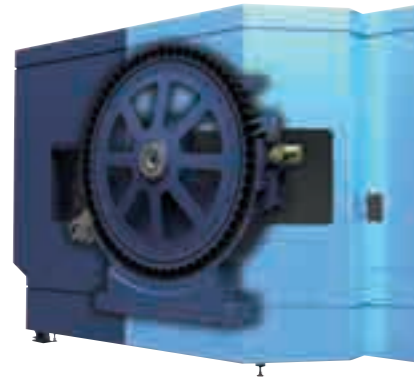

120-tool Chain Magazine

Option

Chain type ATC; reduces tool indexing time by 20%, enhancing high speed production runs that require fast tool changes during short machining operations.



Matrix Magazines

Option

Faster tool transport with the servo-driven tool transfer arm. The "209-tool high-speed type", and "245-tool large-capacity type" are available for selection according to requirements. This strengthens support for multiproduct variable-quantity production, prolonged unmanned operation, and high-speed machining.

Matrix Magazine	
High-speed type	Capacity up to 209 tools (114 / 144 / 174 / 209) • Tool transfer time shortened by optimizing the tool rack arrangement
Large-capacity type	Capacity up to 245 tools (120 / 150 / 180 / 210 / 245)



Maximum tool size

(in.)

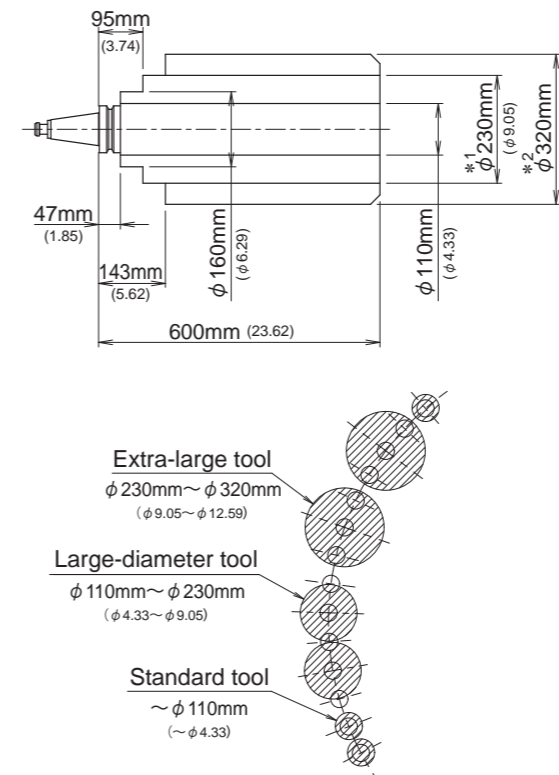

Tool shank	JIS B 6339 Tool Shank 50T
Pullstud	JIS B 6339 Pullstud 50P
Max. tool diameter	ϕ 110mm (ϕ 4.33) ϕ 230mm (ϕ 9.05) (*1. No adjacent tool/with specified storage space) ϕ 320mm (ϕ 12.59) (*2. No adjacent tool/with specified storage space) * Tools with ϕ 320 mm (12.59) in diameter can be mounted side by side, provided that two empty pots are required between them.
Max. tool length	600mm (23.62)
Max. tool math	20kg (44 lb.) (The tool moment load must not exceed 2 kgm.)

PC6 Floor Pallet System

Option



Pressure Supply for Fixtures-Feature*

Option

A through pallet pressure supply feature as an option is available on the *H.Plus-630*.

* Please note; if the through pallet pressure supply feature is selected as an option the supply source, solenoid valves, pressure switches, gap sensors, joints and hoses are not supplied as standard.

	Number of ports	Pressure (MPa)
1. Work station side	2 ports	Max.19.6
2. Machine side	2 ports	Max.19.6

Matsuura's unique X & W structure - superb chip and swarf management.

X-type APC Door

Separating the APC set up station from the machining enclosure is Matsuura's X Type door configuration. This unique design prevents chip build up and accumulation and is designed to handle the high metal removal rates generated by the *H.Plus-630*.

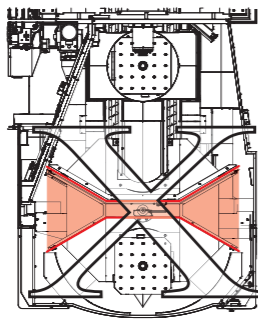

W-type Slide Cover

The W Type configuration with robust telescopic facilitates the fast and efficient evacuation of chips and swarf from the machining enclosure - even at the highest volume of metal removal.

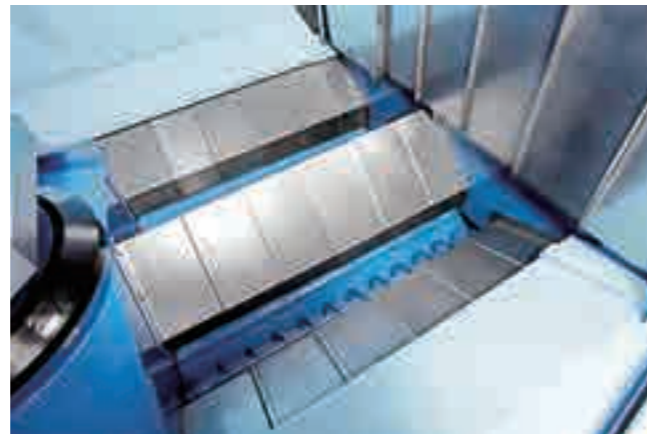
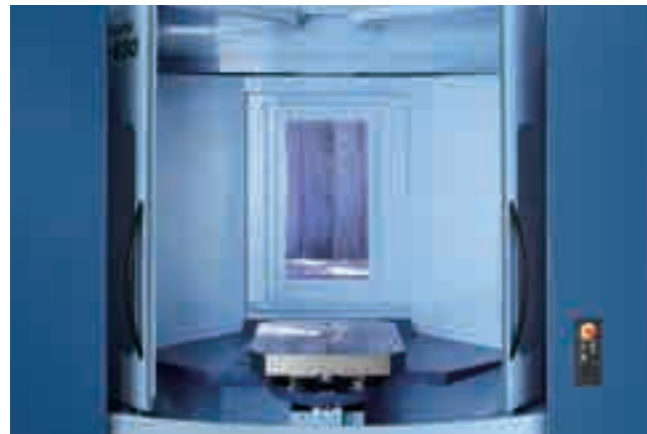

Spiral Chip Conveyor Lift-up Chip Conveyor

- Standard
- Option

Spiral chip conveyors are provided as standard in the gutters to transport chips smoothly to a tank at the rear of the machine. Chip disposal can be automated by installing the optional lift-up chip conveyor.

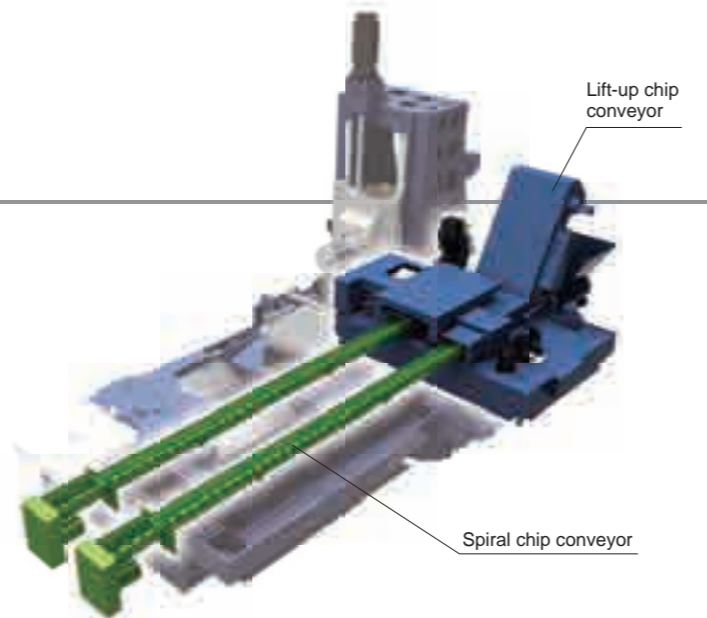

MIMS with New Features for Safety and Security of Machining

MIMS Matsuura Intelligent Meister System

Digitized Meister knowledge, skills and ingenuity
Matsuura's unique interface to maximize rapid operation and usability

Environment

Eco Meister

Power saving

- Power cut-off function
- Energy-saving devices installed

Accuracy

Thermal Meister

Stable accuracy

- Spindle thermal displacement compensation
- X/Y/Z thermal displacement compensation
- Environmental thermal displacement compensation

Simple

Operability Meister

Fuss-free simple operation

- Tool setup support
- Workpiece setup support

Secure

Reliability Meister

Machine downtime reduction

- Preventive maintenance support
- Failure cause analysis
- Electronic manuals
- E-mail function

E-mail function

At the occurrence of an alarm during operation, an e-mail message to notify the alarm can automatically be sent to the registered e-mail addresses. The operating status or machining progress status notification is also possible.

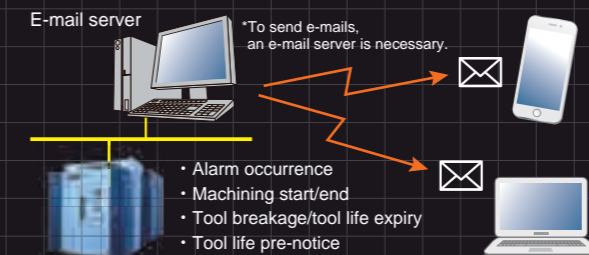

A maximum of 10 e-mail addresses can be set for each notification item.

15-inch touch panel screen adopted

The machine is equipped with a new operating system that features a 15-inch touch panel. Icons required for operation, setup and maintenance are displayed on the screen. Screen display can be switched by single-tapping, and can be customized as needed.



Electronic manuals

Electronic manuals can be viewed on the main operation panel. Search features and bookmarks ensure quick access to the information you are looking for.



Standard Machine Specifications

■ Movement and Range			
X-Axis Travel	mm (in.)	1050 (41.33)	
Y-Axis Travel	mm (in.)	920 (36.22)	
Z-Axis Travel	mm (in.)	990 (38.97)	
B-Axis Travel	deg	360	
■ Pallet			
Working Surface	mm (in.)	630x630 (24.8x24.8)	
Loading Capacity	kg (lb.)	1200 (2640)	
Max. Workpiece Size	mm (in.)	φ 1050xH1115 (φ 41.33xH43.89)	
■ Spindle			
Spindle Speed Range	min ⁻¹	45 - 12000 (Oil-Air Lubrication System)	
Spindle Taper	—	7/24 taper # 50 (BT Double Contact Type)	
Spindle Bearing Inner Diameter	mm (in.)	φ 100 (φ 3.93)	
Spindle Motor Power	kW	AC 15 / 26 (Low Speed: Continuous/15%) AC 26 / 30 (High Speed: Continuous/60%)	
Max. Spindle Motor Torque	N·m	451 / 550min ⁻¹	
■ Feed Rate			
Rapid Traverse Rate	X/Y/Z mm/min (ipm)	60000 / 60000 / 60000 (2362.2 / 2362.2 / 2362.2)	
	B min ⁻¹	75	
Feed Rate	X/Y/Z mm/min (ipm)	1 - 60000 (0.03-2362.2)	
	B min ⁻¹	0 - 75	
■ Automatic Tool Changer			
Type of Tool Shank	—	JIS B 6339 tool shank 50T	
Pullstud	—	JIS B 6339 pullstud 50P	
Tool Storage Capacity	pcs.	60	
Max. Tool Diameter	mm (in.)	φ 110 (φ 4.33) (Adjacent tool exists) φ 320 (φ 12.59) (No adjacent tool)	
Max. Tool Length	mm (in.)	600 (23.62)	
Max. Tool Mass	kg (lb.)	20 (44) (Tool moment load to be less than 2 kgm)	
Methods of Tool Selection	—	Fixed address (Rack type ATC magazine: fixed address)	
Tool Changing Time: Tool to Tool	sec	2.2 (When tool mass is 10 kg or less) 3.1 (When tool mass is over 10 kg)	

■ Automatic Pallet Changer			
Number of Pallets	pallets	2	
■ Power Sources			
Power Capacity	kVA	97 (Depends on the optional features)	
Required Air Volume	NL/min	600	
■ Tank Capacity			
Coolant Tank Capacity	L	600	
■ Machine Size			
Machine Weight	kg (lb.)	21000 (46297)	
■ NC System			
Control System	—	Matsura G-Tech 31i	
■ Standard Accessories			
01. Total Splash Guard	02. Pallet Magazine Safety Guard		
03. ATC Auto Door	04. Synchronized Tapping		
05. AD-TAP Function	06. IPC Function		
07. Spindle Oil Cooler	08. Auto Grease Supply Unit for X/Y/Z		
09. Air Dryer	10. Spindle Overload Protection		
11. 9 sorts of M-code Counters	12. Spiral Chip Conveyor (L/R)		
13. Work Light	14. Machine Color Paint		
15. Levelling Pads and Bolts	16. Spindle Run Hour Meter		
17. Feed Axis Interference Protection (with OT Software)			
18. Standard Mechanical Tool and Tool Box			
19. Matsuura Intelligent Meister System (MIMS)			
20. PC Tool for Memory Card Program Operation and Editing			
21. Auto Operation Integrator			

* Spindle two-year warranty

List of Fittings

■ Spindle			
12000 min ⁻¹ (BT50 Oil-Air Lubrication System)			○
15000 min ⁻¹ (BT50 Oil-Air Lubrication System)			▲
10000 min ⁻¹ (BT50 Oil-Air Lubrication System)			
Spindle motor output	kW	Low : 18.5 / 22、High : 26 / 30	▲
Spindle max. torque	N·m	700 (300min ⁻¹)	
■ ATC			
60 tools (Drum magazine)			○
120 tools (Chain magazine)			▲
120 / 150 / 180 / 210 / 245 tools (Matrix magazine: 245-tool base)			▲
114 / 144 / 174 / 209 tools (Matrix magazine: 209-tool base)			▲
Max. tool mass: 30 kg			▲
■ High-precision Control			
Scale Feedback X/Y/Z			▲
■ APC			
PC2			○
PC6 (Floor Pallet System)			▲
■ Pallet			
<input type="checkbox"/> 630	Working Surface	mm (in.)	630x630 (24.8x24.8)
	Loading Capacity	kg (lb.)	1200 (2640)
	Max. Workpiece Size	mm (in.)	φ 1050xH1115 (φ 41.33xH43.89)
			○
■ Coolant			
Coolant Tank			○
Vacuum-Type Coolant Through A 7MPa			▲
Vacuum-Type Coolant Through A 14MPa			▲
Vacuum-Type Coolant Through B 7MPa			▲
Vacuum-Type Coolant Through B 14MPa			▲
Vacuum-Type Coolant Through C 2MPa			▲
Vacuum-Type Coolant Through C 7MPa			▲
Coolant Flow Checker (with through-spindle coolant)			▲
Coolant Flow Checker (without through-spindle coolant)			▲
Coolant Temperature Controller with 100-liter Tank (installed separately); small 100ℓ			▲
Coolant Temperature Controller with 200-liter Tank (installed separately); large 200ℓ			▲

■ Automatic Measurement/Tool Damage Check	
Automatic Measurement/Automatic Centering (optical type)	▲
Tool Damage Check/Full Automatic Tool Length Measurement (contact type)	▲
Tool Damage Check/Full Automatic Tool Length Measurement (laser type)	▲
Automatic Measurement (optical type) and Tool Damage Check (contact type)	▲
Automatic Measurement (optical type) and Tool Damage Check (laser type)	▲
■ Chip Disposal	
Full Splash Guard	○
ATC Auto Door	○
Two Spiral Chip Conveyors	○
External Nozzle 2 MPa (with spindle through)	▲
External Nozzle 7 MPa (with spindle through)	▲
Lift-Up Conveyor (scraper and drum)	▲
Lift-Up Conveyor (hinge + scraper and drum)	▲
Chip Bucket	▲
Chip Removal Air Blow	▲
Workpiece Cleaning Gun (Main unit side)	▲
Workpiece Cleaning Gun (APC side)	▲
■ Control/Maintenance Support	
AD-TAP Function	○
IPC Function	○
MIMS (Matsuura Intelligent Meister System)	○
Feed Axis Auto Lubricator	○
Work Light	○
Spindle Operation Integrator	○
Automatic Operation Indicator	○
Eight additional M functions	▲
Spindle Load Monitoring Function	▲
Weekly Timer	▲
Rotary Wiper (air type)	▲
Rotary Wiper (electric type)	▲
100 VAC outlet (3A)	▲
Optional block skip addition	▲
Reliability Meister Plus	▲
■ Safety Device	
Matsuura Safety Specifications	○
Automatic Fire Extinguisher	▲
■ Optional Package	
High-speed, High-precision Package	▲
Value Package	▲

○ : Standard ▲ : Option

Floor Plan Unit: mm (in.)

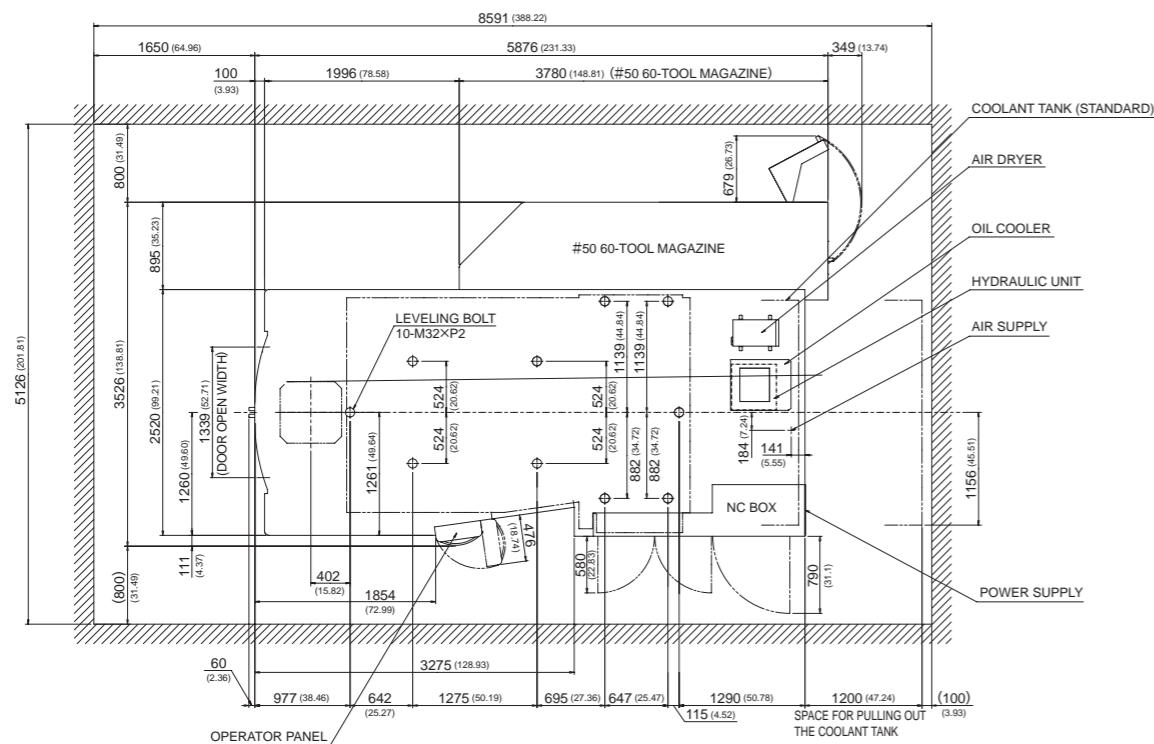

External View Unit: mm (in.)

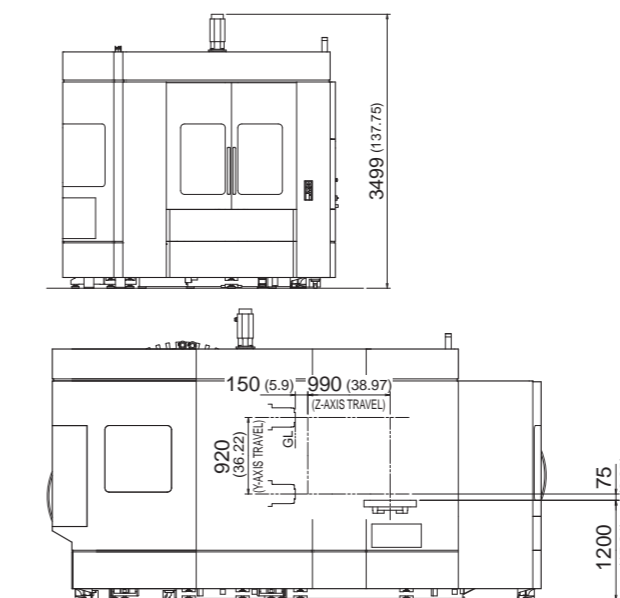

Pallet Top View Unit: mm (in.)

